

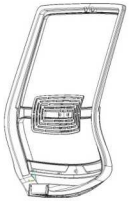

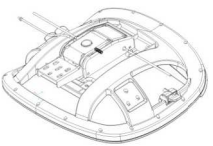

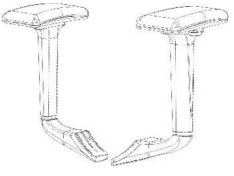
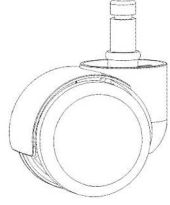

**IMPORTANT NOTICE:
HARDWARE PACKAGE IS ATTACHED
ON THE BOTTOM OF SEAT CUSHION.**

MODEL : B6033/B6033-HR

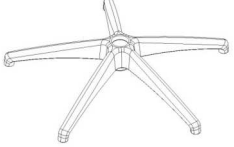
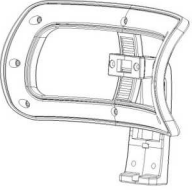
(1) X 1	(2) X 1	(3) x 1 (L) x 1 (R)
		
Back Cushion	Seat Cushion W/Mechanism	Right & Left Arm
(4) X 5	(5) x 1	(6) x 1
		
Casters	Gas Lift W/ Cover	Base
(7) X 1	(8) X 1	
		
Headrest	Decorative Cover	
(A) X 4	(B) X 6	(C) X 2
		
Screws 5/16*3/4	Screws 1/4*1-1/4	Screws 1/4*3/4

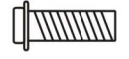
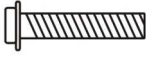

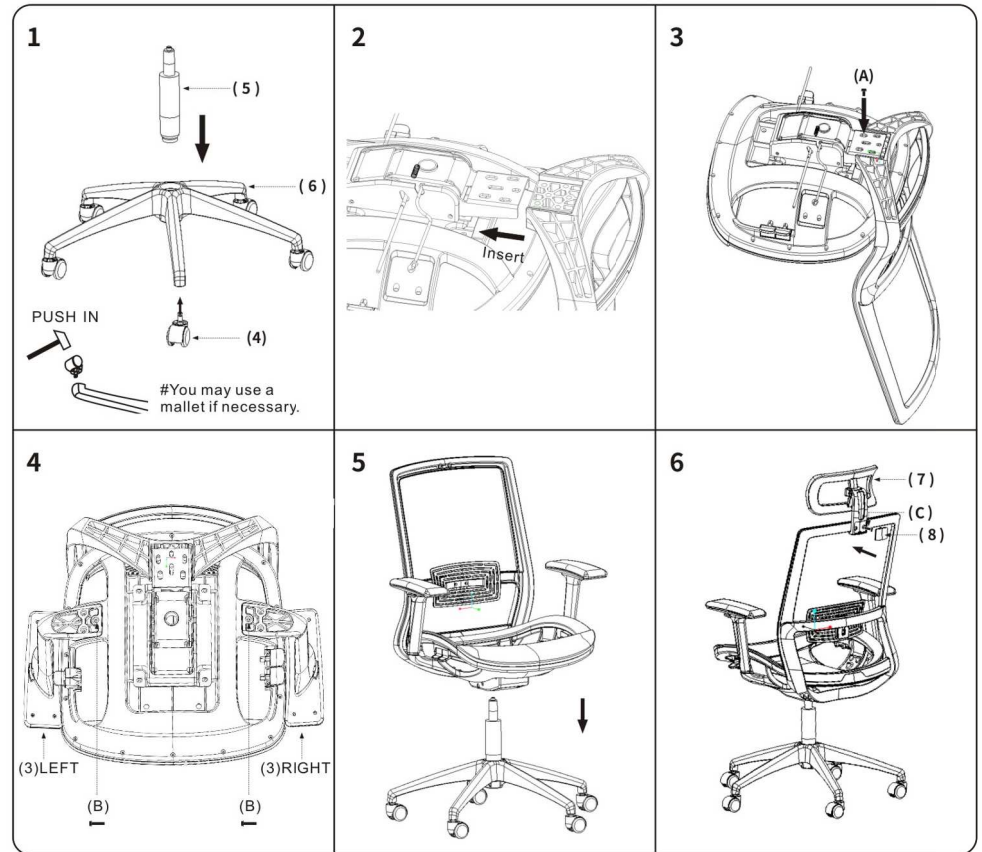
Insert and loosely tighten all screws. When assembly is completed, fully tighten all screws before using. This chair is only intended for sitting. Any other use will void the warranty.

