

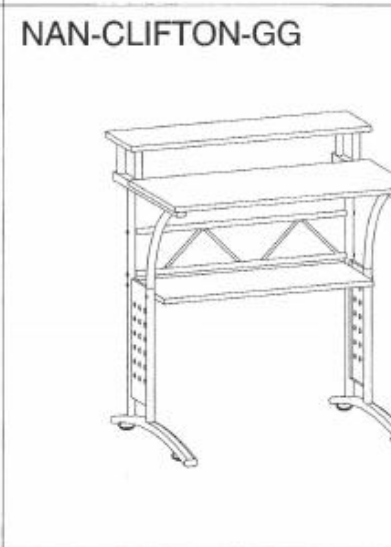

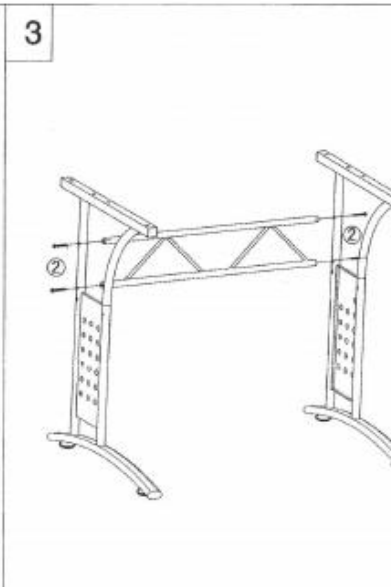

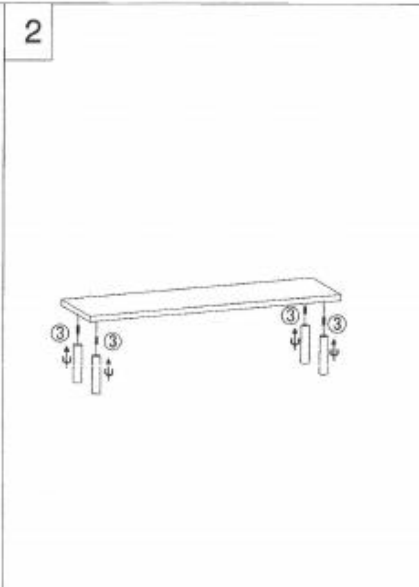

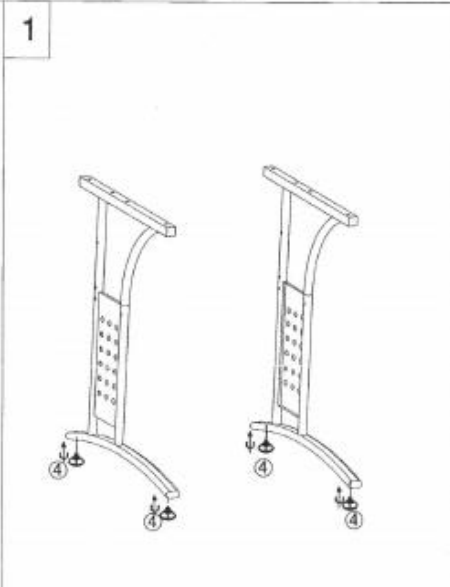







- ①  5X55X4
- ②  M6X35X12
- ③  M6X20X4
- ④  M8X4



X-5M

Assembly instructions

PARTS

<p>① X 1</p> 	<p>A.M6*25 X 4</p> 
<p>② X 1</p> 	<p>B.M6*20 X 4</p> 
<p>③ X 1</p> 	<p>C.M6*35 X 4</p> 
<p>④ X 1</p> 	<p>D.X 4</p> 
<p>⑤ X 1</p> 	<p>E.X 1</p> 
<p>⑥ X 1</p> 	<p>F.X 5</p> 
<p>⑦ X 1</p> 	<p>G.X 2 H.X 2</p> 

NOTICE:
EVERY 6 MONTHS, PLEASE MAKE SURE ALL BOLTS,
SCREWS AND KNOBS ARE FULLY TIGHTENED TO
ENSURE STABILITY.

STEP 1

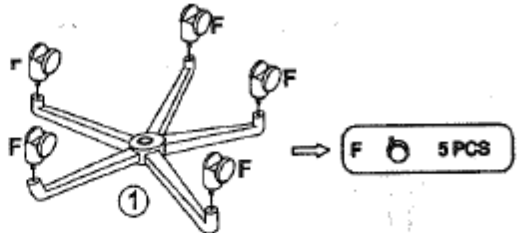

STEP 2

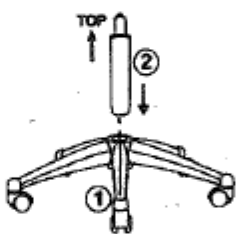

STEP 3

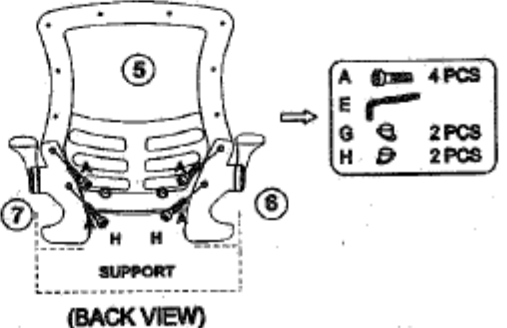

(BACK VIEW)

STEP 4

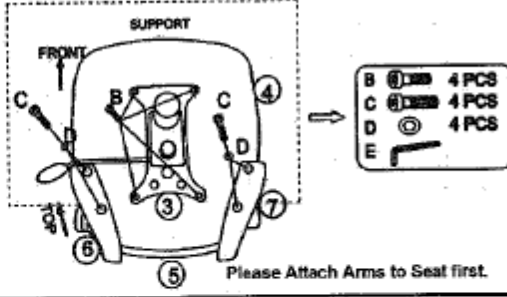

FRONT

SUPPORT

Please Attach Arms to Seat first.

STEP 5

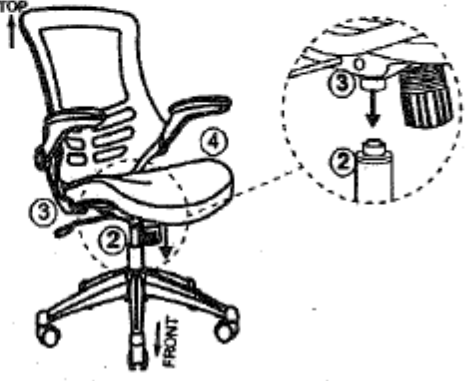

TOP

FRONT