

BT-827-1
PARTS

ASSEMBLY INSTRUCTION

(1)X1

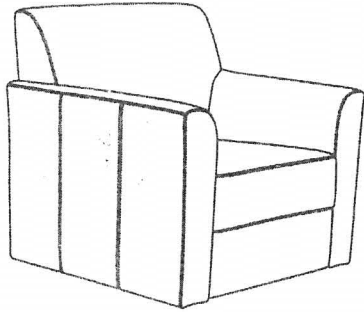

(2)X4

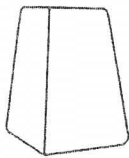

(3)X4

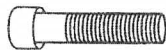

(4)X1

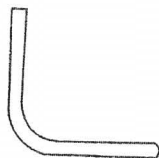

①

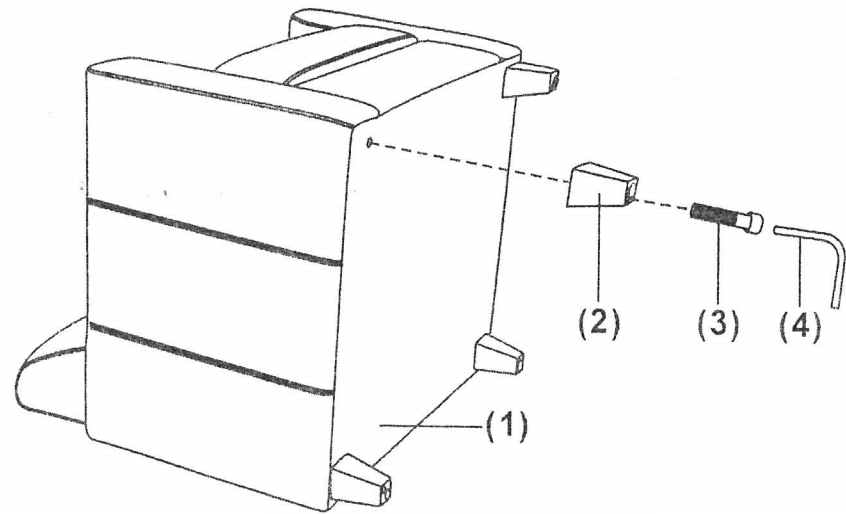

②

