



Thank you for your purchase!

Racing Style Leathersoft Ergonomic Gaming Chair

ASSEMBLY INSTRUCTIONS

Before You Begin:

Please identify all component parts and hardware pieces required before you begin. Carefully remove all of the components from the packaging and set aside for assembly. Assemble on a soft surface to prevent scratching during assembly.

Caution:

Tighten all components securely before use. Failure to do so may result in personal injury. DO NOT use any sharp objects to open plastic wrapped components as damage to product or components may result.

Warning:

CHOKING HAZARD - Small Parts. Adult Assembly Required.

Injury may result from tipping furniture. You must install the Tipping Restraint Hardware with the unit to prevent the unit from tipping and causing any accidental injury, instability, death or damage. The tipping restraint is intended only as a safety measure, it is not a substitute for proper adult supervision.

This tipping restraint is not an earthquake restraint. If you wish to add the extra security of earthquake restraints, they must be purchased and installed separately.

Serious or fatal crushing injuries can occur from furniture tipping over. To prevent furniture from tipping over it must be permanently fixed to the wall. Fixing devices for the wall are not included since different wall materials require different types of fixing devices. Use fixing devices suitable for the walls in your home.

Failure to detach this restraint before moving furniture may result in injury or damage.

DO NOT ALLOW CHILDREN TO CLIMB ON FURNITURE

Our Warranty Statement

This warranty covers manufacturing defects associated with your new product. The product is warranted from the original purchase date and to the original purchaser for normal usage, according to the below-referenced specifications and limitations.









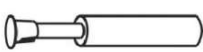

- Non-moving metal parts are warranted for 5 years.
- Component parts including pneumatic cylinder, control mechanism, base and casters are warranted for 2 years.
- All other items are warranted for 1 year.

Normal usage means use in compliance with the restrictions and weight limits specified for the product. In the absence of product-specific restrictions and weight limits, normal usage means use for no more than forty hours per week by persons weighing 250 lbs. or less.

Coverage terminates if the product is sold or otherwise transferred. Repairs made by parties other than Belnick also void this warranty.

This warranty will not cover: (1) labor, freight, or damage from misuse, abuse, negligence, alteration, assembly, installation, attachments, accident, vandalism, acts of nature or any other event beyond the control of Belnick; (2) tearing, scratching, scuffing, or blemishing of leather or fabric; (3) cosmetic damage that may result from normal usage; (4) damage attributable to use by persons exceeding specified weight limits or commercial use exceeding forty hours per week; or (5) rust or other damage caused by exposure to moisture. The user assumes all risk of injury resulting from use of this product. Liability for incidental or consequential damage is excluded. Some states do not allow the exclusion or limitation of incidental or consequential damages, so the above limitation or exclusion may not apply to you.

PARTS

| | | | | | | | | |
|----------|---|---|----------|---|---|-----------|---|----|
| 1 |  | 1 | 5 |  | 1 | 9 |  | 4 |
| 2 |  | 1 | 6 |  | 1 | A: |  | 12 |
| 3 |  | 1 | 7 |  | 1 | B: |  | 6 |
| 4 |  | 1 | 8 |  | 5 | C: |  | 1 |

STEP 1

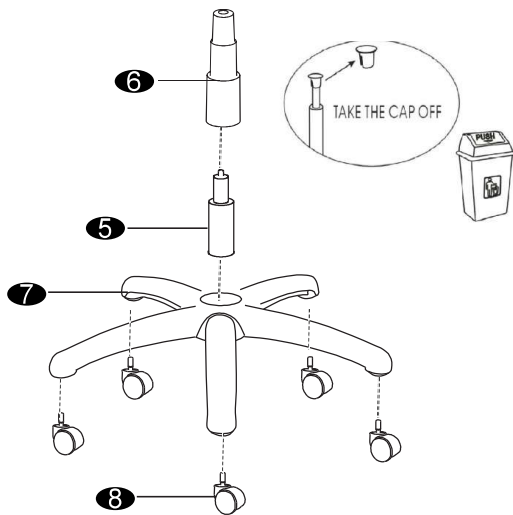

STEP 2

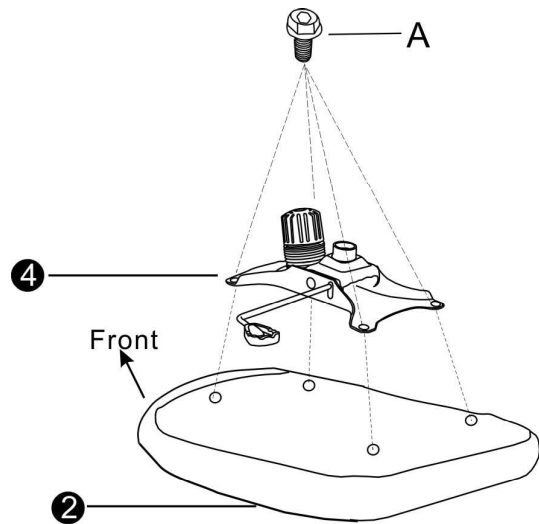

STEP 3

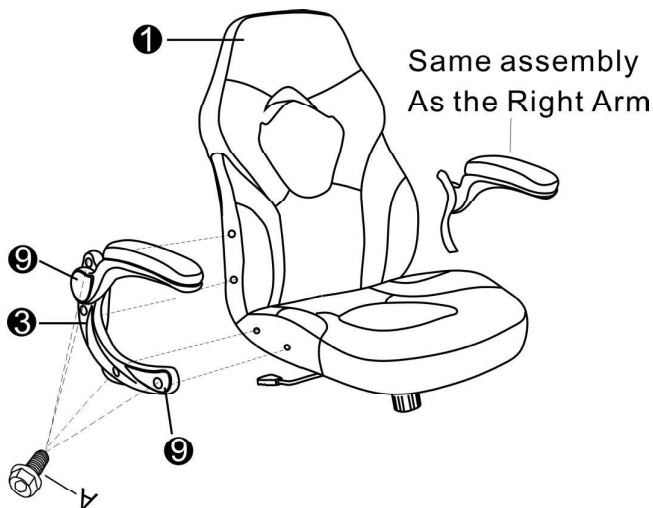

STEP 4

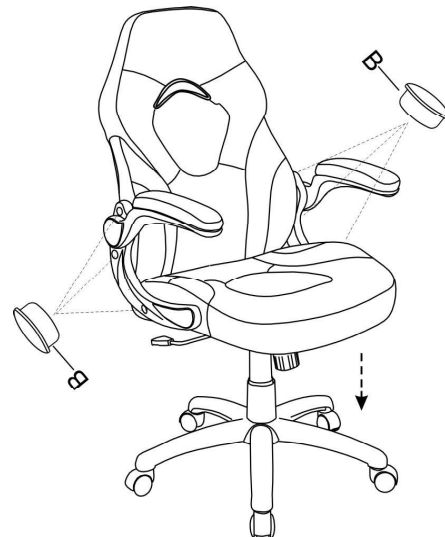

Thank you for your purchase!