

*Thank you for your purchase!*



# Height Adjustable Table

## ASSEMBLY INSTRUCTIONS

### **Before You Begin:**

Please identify all component parts and hardware pieces required before you begin. Carefully remove all of the components from the packaging and set aside for assembly. Assemble on a soft surface to prevent scratching during assembly.

### **Caution:**

Tighten all components securely before use. Failure to do so may result in personal injury.

DO NOT use any sharp objects to open plastic wrapped components as damage to product or components may result.

### **Warning:**

**CHOKING HAZARD** - Small Parts. Adult Assembly Required.

### **DO NOT ALLOW CHILDREN TO CLIMB ON FURNITURE**

Serious or fatal injuries can occur from furniture tipping over. You must install Tipping Restraint Hardware (where included) to help prevent the unit from tipping and causing accidental injury, instability, death or damage. The tipping restraint is intended only as a safety measure, it is not a substitute for proper adult supervision.

To help prevent furniture from tipping over it must be permanently attached to the wall. Anti-Tip Safety Wall Straps suitable for the unit weight and wall materials (if not included) should be purchased and installed.







Part	Drawing	Description	Qty	Part	Drawing	Description	Qty
	<b>Hardware List</b>						
①		Top Platform	1 EA	A		Flat Head Screw	4 EA
②		Top Support	1 EA	C		Cylinder	1 EA
③		Five Star Base	1 EA	D		2" Caster	5 EA
						Allen Wrench	1 EA

Illustration # 1

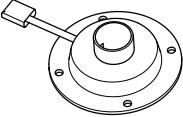

**To Assemble:**

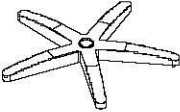
1. Identify and Separate all the Parts and Hardware.
2. Place the Top Panel (Part 1) with the insert nuts facing up and attach Top Support (Part 2) using 4 Flat Head screws (Part A) as shown in the Illustration # 1. Tighten the screws using Allen wrench

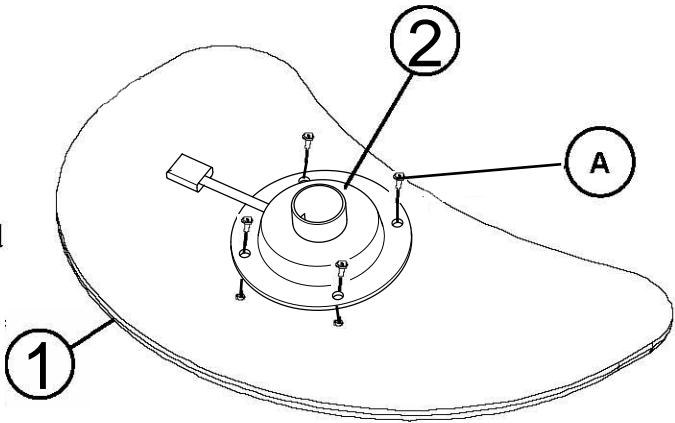

Illustration # 2

3. Attach 5 Casters ( Part D ) to the Five Star Base ( Part 3 ) as shown in Illustration # 2.

4. Insert Cylinder ( Part C ) in the Top Support ( Part 2 ) as shown in Illustration # 3.

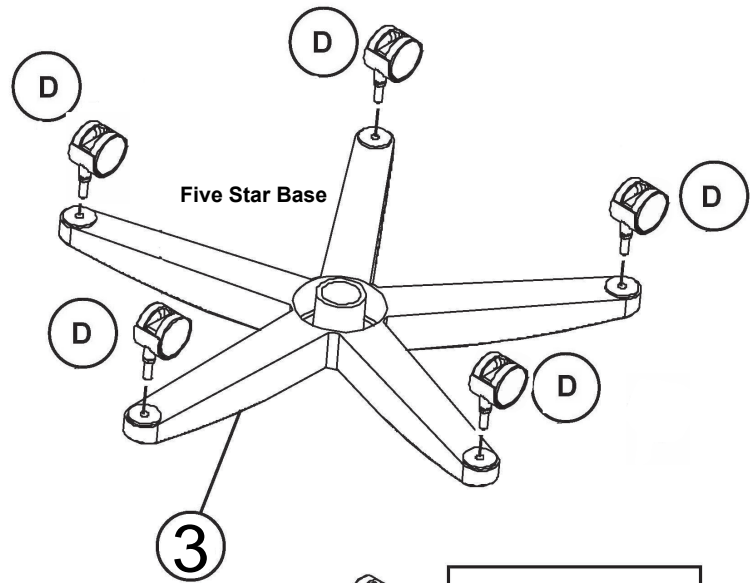
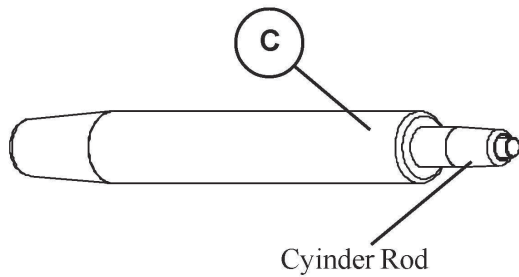
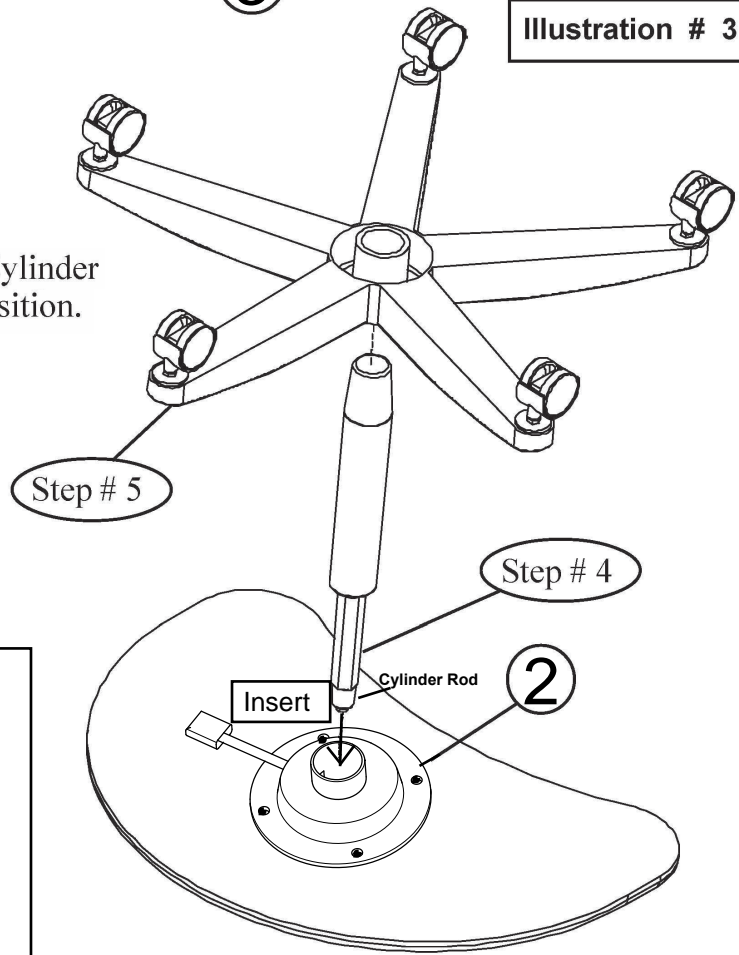

Illustration # 3

5. Attach Five Star Base ( Part 3 ) on the Cylinder ( Part C ). Place the unit in Upright position.



**Tighten all screws before use and periodically check to ensure screws remain tightened. If parts are missing, broken, damaged or worn stop use of this product until repairs are made by your dealer using factory authorized parts.**