

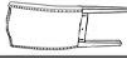





ASSEMBLY INSTRUCTION

Hardware List

A		Sest	1PC
B		Chair	1PC
C		Legs	2PCS
E		Bolts	5PCS
F		Bolts	4PCS
G		Washer	9PCS
H		Allen Key	1PC

PRE-ASSEMBLY PREPARATION:

1. Please put on clean space to assemble to avoid damages on chairs.
2. About hardwares: tighten all screws firstly 90%; adjust the legs to level; tighten the screws the remainig 10%.
3. weight capacity: 300 pounds.

Step1

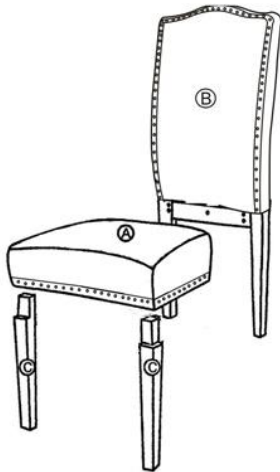

Step2

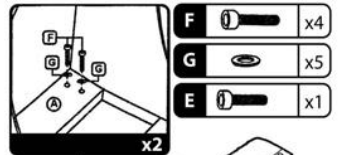

Finger tighten Bolt **E** and Bolts **F** attaching the Seat **A** to the Back **B**

Step3

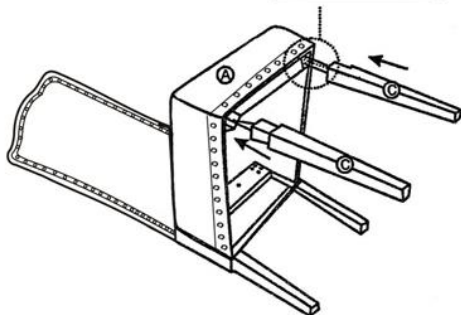
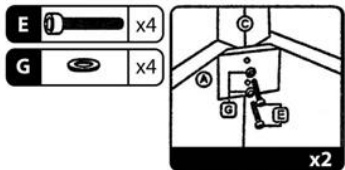

Step4

