

Fixed TV Wall Mount 17"-42"
Soporte fijo de pared para TV 17"-42"

PRODUCT GUIDE
GUIA de PRODUCTO

IMPORTANT SAFETY INSTRUCTIONS

When using this mounting system, basic precautions should be followed including the following:
Read the entire instruction manual before you start installation and assembly.

- ⚠ CAUTION:** Use with products heavier than the rated weight (29.93kg/66lbs) may result in instability and injury.
1. Mounts must be attached as specified instruction. Improper installation may result in damage or serious injury.
 2. Use this mounting system only for its intended use as described in these instruction. Do not use attachment not recommended by the manufacturer.
 3. Safety gear and proper tools must be used.
 4. Make sure that the supporting surface will safely support the combined weight of the equipment and all attached hardware and components.
 5. This product contains small item that could be a choking hazard if swallowed. Keep these items away from children.
 6. This product is intended for indoor use only. Using this product outdoor could lead to product failure and personal injury.

IMPORTANT

Ensure that you have received all parts according to the component checklist prior to installation.

DANGER - To reduce the risk of electrical shock:

1. Always unplug the monitor and connected components before cleaning this mounting system.
2. Unplug monitor and connected components from outlet before putting on or taking off parts.
3. Route cords and cables as shown in the installation instructions.

INSTRUCCIONES IMPORTANTES DE SEGURIDAD

Cuando se utiliza este sistema de montaje, se deben tomar precauciones básicas, incluidas las siguientes:
Lea todo el manual de instrucciones antes de comenzar la instalación y ensamble de la unidad.

⚠ PRECAUCIÓN: Utilizar con productos de mayor peso al indicado (29.93kg/66lb) en los límites de peso podría ocasionar inestabilidad y posibles heridas personales.







1. Los soportes deben acoplarse tal como se indica en las instrucciones de ensamble. una incorrecta instalación podría ocasionar daños y serias heridas personales.
2. Utilice este sistema de montaje sólo para su uso como se describe en estas instrucciones. No use accesorios no recomendados por el fabricante.
3. Utilice las herramientas y equipo de seguridad adecuados.
4. Asegúrese de que la superficie de fijación sostenga de manera segura el peso total del equipo y todos sus componentes y hardware.
5. Este producto contiene piezas pequeñas que representan un riesgo de asfixia. Mantenga estas piezas fuera del alcance de los niños.
6. Este producto está diseñado para uso en interiores solamente. Utilizar este producto en exteriores podría ocasionar fallas y heridas personales.

IMPORTANTE. Asegúrese de que haya recibido todas las piezas según la lista de verificación de componentes para la instalación.

PELIGRO: para reducir el riesgo de descarga eléctrica:

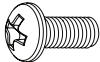

1. Siempre desenchufe el monitor y los componentes conectados antes de limpiar este sistema de montaje.
2. Desenchúfelo del monitor y los componentes conectados de la toma de corriente antes de colocar o quitar piezas.
3. Tender los cables como se muestra en las instrucciones de instalación.

TV Hardware(Package M) / Hardware de TV (paquete M)

						
M-A - M4x15 (x4) Bolt / Tornillo	M-B - M5x15 (x4) Bolt / Tornillo	M-C - M6x15 (x4) Bolt / Tornillo	M-D - M8x20 (x4) Bolt / Tornillo	M-E - M5 (x4) Washer / Arandela	M-F - M8 (x4) Washer / Arandela	M-G - 5mm(x8) Spacer / Espaciador

Wall Hardware (Package W)

Herrajes de pared (paquete W)

		
W-A - Lag Bolt (x4) Tornillo	W-B - Wall Anchor (x4) Anclaje de Pared	W-C - Washer (x4) Arandela

A (x1) Wall Plate Unit
Unidad de Placa de Pared

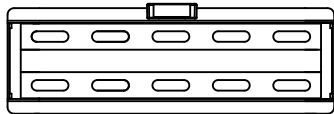

D (x1) Paper Template
Plantilla de Papel

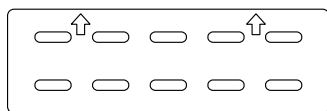

B (x1) TV Left Bracket
TV Soporte Izquierdo



C (x1) TV Right Bracket
TV Soporte Derecho

Tool Needed (Not Included)
Herramienta Requerida/ No incluidas



Power drill
Taladro eléctrico

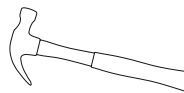

Hammer
Martillo



Phillips screwdriver
Destornillador Phillips



10mm
Socket Wrench
Llave de tubo



Drill Bit
Broca
3/16"



Drill Bit
Broca
3/8"



Stud Finder
Detector de vigas

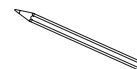

Pencil
Lápiz

1A

Wood Stud installation requires a minimum 2x4 inch wood stud with 3/8 inch thick dry wall. Locate studs with a stud finder. Hold the paper template (D) against the wall to mark two holes. Check level with the bubble level and drill holes with a 3/16" (4.5mm) drill bit to a depth of 2.2" (55mm). Attach wall plate (A) with two bolts (W-A) and washer (W-C) using a socket wrench.

La instalacion de postes de madera requiere un minimo de 2x4 pulgada de madera con pared seca de 3/8 de pulgada de espesor Localizar tacos con un buscador de postes. Sostenga la plantilla de papel (D) contra la pared para marcar dos agujeros con un Broca 3/16" (4.5 mm) a una profundidad de 2.2" (55 mm). Fije la placa de pared (A) con dos pernos (W-A) y arandelas (W-C) con un llave de tubo.

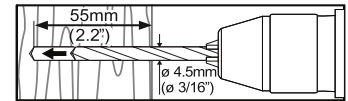
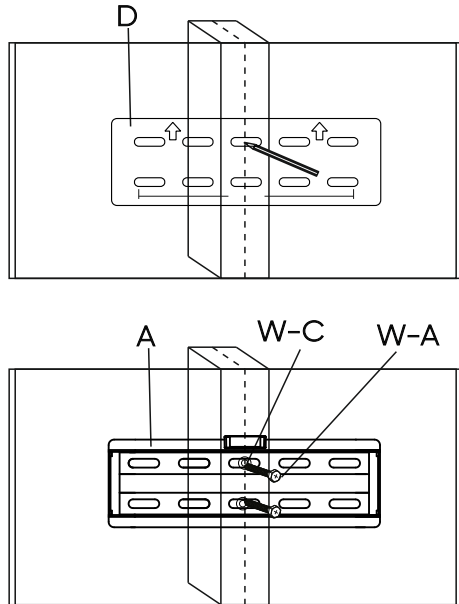

**NEVER USE WALL ANCHORS
NUNCA UTILICE ANCLAJES
DE PARED**

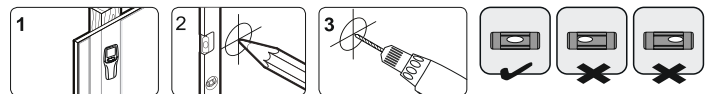

1B Concrete wall installation requires a minimum of 8 inch thick solid concrete. Hold the paper template (D) against the wall to mark four holes according to actual TV VESA. Check level with the bubble level and drill holes with a 3/8" (10 mm) drill bit to a depth of 2.2" (55 mm) tap four wall anchors (W-B) into the wall using a hammer. Attach wall plate (A) with four bolts (W-A) and washers (W-C) using socket wrench.

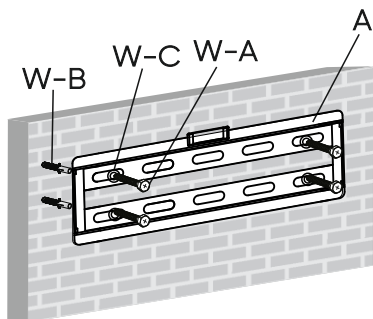
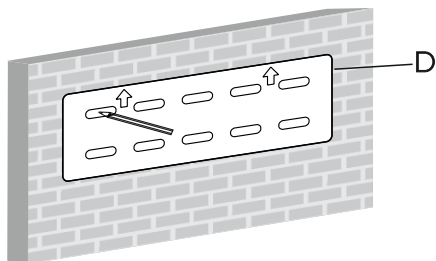

La instalacion de un muro de hormigon requiere concreto solido de espesor minimo de 8 pulgadas. Sostenga la plantilla de papel (D) contra la pared para marcar cuatro agujeros de acuerdo a la TV actual VESA. Compruebe el nivel con nivel de burbuja y taladar agujeros con una barca de 3/8" (10 mm) a una profundidad de 2.2" (55 mm) Top cuatro anclajes de pared (W-B) en la pared. Con un martillo. Fije la placa de pared (A) con cuatro pernos (W-A) y lavadora (W-C) usando un llave de tubo.

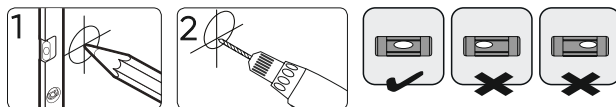
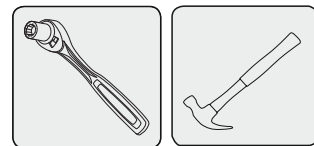
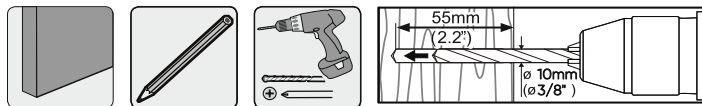

2 With a Phillips screwdriver, attach the left TV bracket (B) and right TV bracket (C) to the back of the TV where shown. Choose the appropriate bolts, washer, and spacers for your TV. Make sure that the pull straps are nearest to the left (B) or right (C) edges of the TV respectively.

Con un destornillador Phillips, conecte el televisor izquierdo soporte (B) y soporte de TV derecho (C) a la parte posterior del televisor donde se muestra. Elegir el Pernos, arandelas y espaciadores apropiados para tu televisor Asegúrese de que las correas de tracción estén más cercano a los bordes izquierdo (B) o derecho (C) del TV respectivamente.

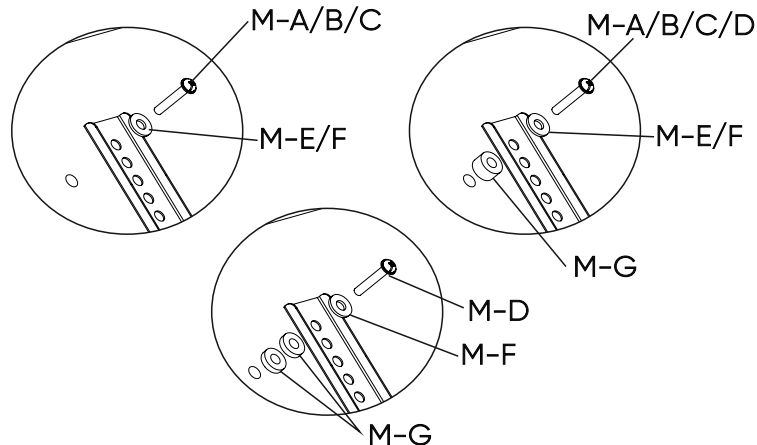
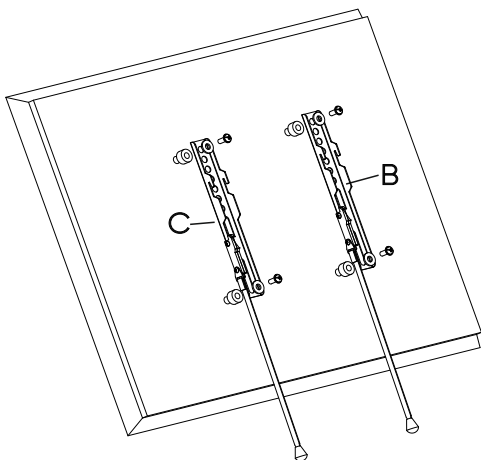
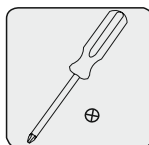
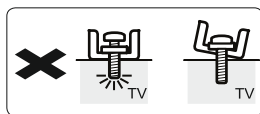
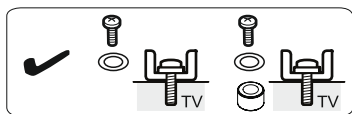

- 3 TWO PEOPLE must hang the TV with the TV bracket (B and C) on the wall plate (A). The latch shown below will click when the TV is properly locked into place.

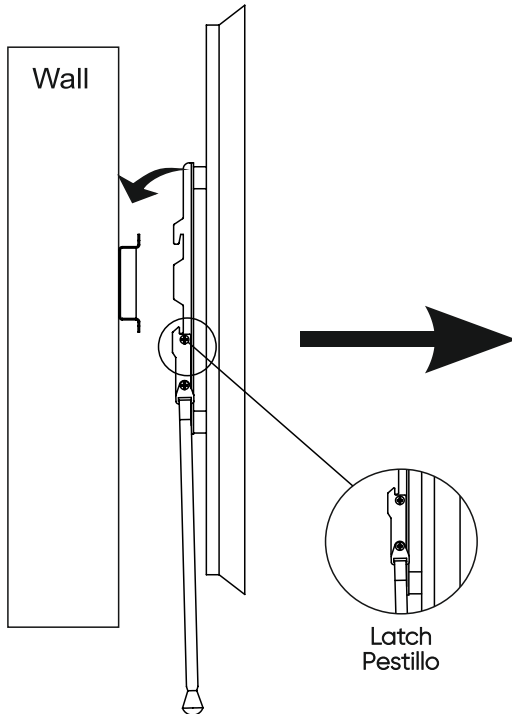

- DOS PERSONAS deben colgar la TV con los soportes (B y C) en la placa de pared (A). El pestillo que se muestra a continuación hará clic cuando la TV se trabe correctamente en su lugar.

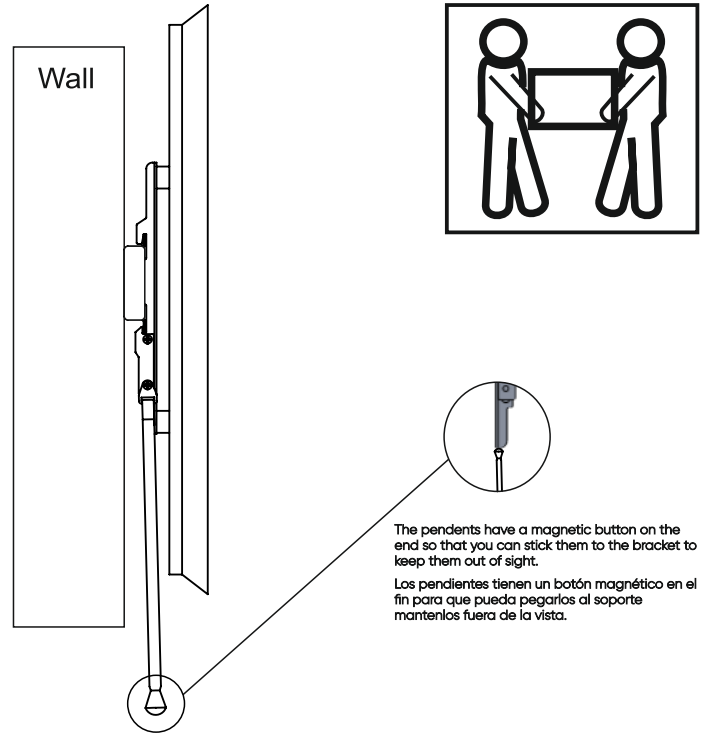

- 4 TWO PEOPLE are needed to remove your TV from the wall. While one person holds the TV, the second person pull down on both release straps, unlocking the TV. TWO PEOPLE must hold and then remove the TV from the wall by first lifting up.

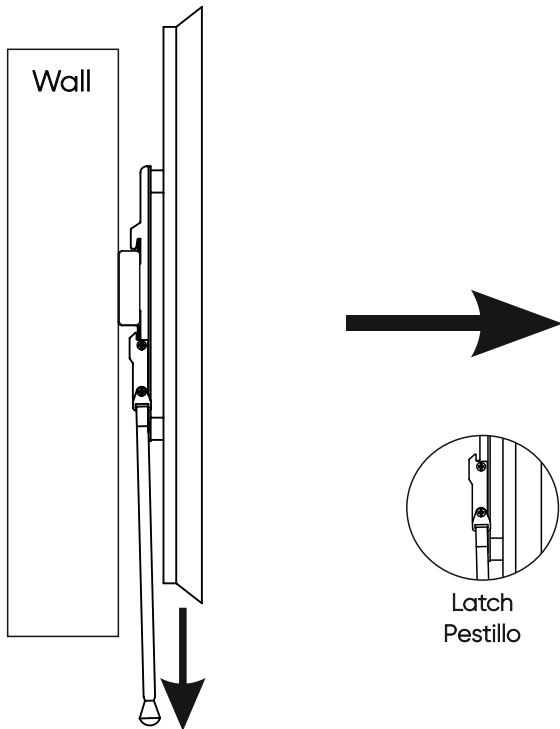

Se necesitan DOS PERSONAS para quitar su televisor de la pared. Mientras una persona sostiene el televisor, la segunda persona tira de ambas correas de liberación y desbloquea el televisor. DOS PERSONAS deben sostener y luego quitar el televisor de la pared levantando primero.

