

Thank you for your purchase!

3-Seat Outdoor Steel Converting Patio Swing

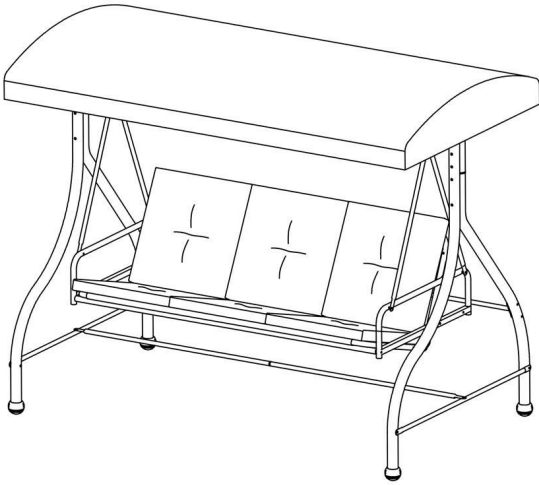

ASSEMBLY INSTRUCTIONS

Before You Begin:

Please identify all component parts and hardware pieces required before you begin. Carefully remove all of the components from the packaging and set aside for assembly. Assemble on a soft surface to prevent scratching during assembly.

Caution:

Tighten all components securely before use. Failure to do so may result in personal injury. DO NOT use any sharp objects to open plastic wrapped components as damage to product or components may result.

Warning:

CHOKING HAZARD - Small Parts. Adult Assembly Required.

Injury may result from tipping furniture. You must install the Tipping Restraint Hardware with the unit to prevent the unit from tipping and causing any accidental injury, instability, death or damage. The tipping restraint is intended only as a safety measure, it is not a substitute for proper adult supervision.











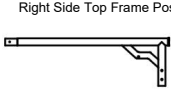

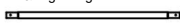





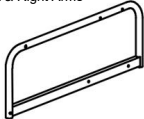

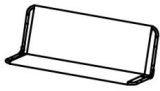



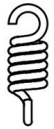





This tipping restraint is not an earthquake restraint. If you wish to add the extra security of earthquake restraints, they must be purchased and installed separately.

Serious or fatal crushing injuries can occur from furniture tipping over. To prevent furniture from tipping over it must be permanently fixed to the wall. Fixing devices for the wall are not included since different wall materials require different types of fixing devices. Use fixing devices suitable for the walls in your home.

Failure to detach this restraint before moving furniture may result in injury or damage.

DO NOT ALLOW CHILDREN TO CLIMB ON FURNITURE

PARTS

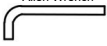
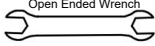
<p>A</p> <p>Left Side Top Frame Post</p>  <p>1PC</p>	<p>B</p> <p>Right Side Top Frame Post</p>  <p>1PC</p>	<p>C</p> <p>Front Legs</p>  <p>2PCS</p>	<p>D</p> <p>Back Legs</p>  <p>2PCS</p>	<p>E</p> <p>Left & Right Leg Bottom Braces</p>  <p>2PCS</p>	<p>F</p> <p>Left Side Upper Stabilizing Bar</p>  <p>1PC</p>	<p>G</p> <p>Right Side Upper Stabilizing Bar</p>  <p>1PC</p>
<p>H</p> <p>Left Side Lower Stabilizing Bar</p>  <p>1PC</p>	<p>I</p> <p>Right Side Lower Stabilizing Bar</p>  <p>1PC</p>	<p>J</p> <p>Swing Attachment Bars</p>  <p>4PCS</p>	<p>K</p> <p>Left & Right Arms</p>  <p>2PCS</p>	<p>L</p> <p>Front Seat Attachment Bar</p>  <p>1PC</p>	<p>M</p> <p>Swing Seat</p>  <p>1PC</p>	<p>N</p> <p>Fabric Canopy</p>  <p>1PC</p>
<p>O</p> <p>Left & Right Canopy Frame</p>  <p>2PCS</p>	<p>P</p> <p>Seat Cushions</p>  <p>3PCS</p>	<p>Q</p> <p>Rear Seat Bracket Note: Install with open side facing outward</p>  <p>2PCS</p>				
<p>1</p> <p>Swing Attachment Springs</p>  <p>2PCS</p>	<p>2</p> <p>Bolt/Nut/Cap To Attach Legs To Upper Frame Posts</p>  <p>M8 × 105MM 8PCS</p>	<p>3</p> <p>Front Seat Attachment Bar Bolts</p>  <p>M8 × 40MM 2PCS</p>	<p>4</p> <p>Bolt/Nut/Cap for Left and Right Side Lower Seat Back Attachment to Arms</p>  <p>M6 × 75MM 2PCS</p>	<p>5</p> <p>Bolts for Left and Right Side Upper Seat Back Attachment to Arms</p>  <p>M6 × 75MM 2PCS</p>	<p>6</p> <p>Bolt/Nut/Cap For Upper Stabilizing Bar, Left & Right Bottom Leg Braces & Left & Right Side Top Frame Posts</p>  <p>M6 × 55MM 9PCS</p>	<p>7</p> <p>Bolt/Nut/Cap for Rear Seat Bracket</p>  <p>M6 × 45MM 2PCS</p>
<p>8</p> <p>Bolt/Nut/Cap For Swing Attachment Bars</p>  <p>M6 × 40MM 4PCS</p>	<p>9</p> <p>Bolt/Nut/Cap To Attach Left & Right Upper Stabilizing Bar & To Attach Left & Right Lower Stabilizing Bar To Legs</p>  <p>M6 × 30MM 3PCS</p>	<p>10</p> <p>Bolt/Nut/Cap for Left & Right Lower Stabilizing Bar</p>  <p>M6 × 25MM 1PCS</p>	<p>11</p> <p>Wing Nuts for Left and Right Side Upper Seat Back Attachment Bolts (Part 5)</p>  <p>M6 2PCS</p>	<p>12</p> <p>Locking Pin Inserts Into Rear Seat Bracket When Reclined</p>  <p>2PCS</p>	<p>13</p> <p>Canopy Tilt Tension KnobS</p>  <p>2PCS</p>	<p>14</p> <p>Spacer for Lower Seat Back Attachment To Arms</p>  <p>∅ 7X15 2PCS</p>
<p>15</p> <p>Upper Front Leg Caps</p>  <p>∅ 48 2PCS</p>	<p>16</p> <p>Foot Caps</p>  <p>∅ 48 2PCS</p>	<p>17</p> <p>Swing Attachment Bar Sleeves Note: Ensure both bars are encased in sleeve</p>  <p>∅ 16 8PCS</p>	<p>Allen Wrench</p>  <p>Open Ended Wrench</p>  <p>1PCS</p>			

Thank you for your purchase!

STEP 1

1

STEP 1: Attach Left Side Top Frame Post (Part A) to Right Side Top Frame Post (Part B) using (1) M6x55mm Bolt/ Nut/Cap Set (Part 6)

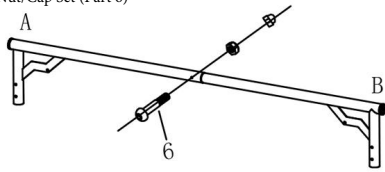

2

STEP 2A: Attach Left & Right Front Legs (Part C) and Left & Right Rear Legs (Part D) to Top Frame using (8) M8x105mm Bolt/Nut/Cap Sets (Part 2).

STEP 2B: Attach Upper Leg Caps (Part 15)

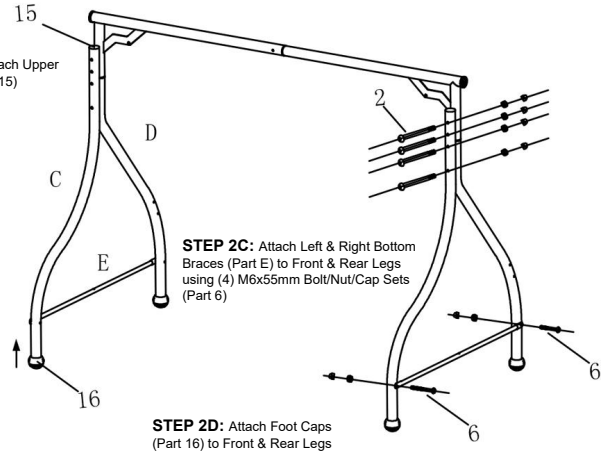

STEP 2C: Attach Left & Right Bottom Braces (Part E) to Front & Rear Legs using (4) M6x55mm Bolt/Nut/Cap Sets (Part 6)

STEP 2D: Attach Foot Caps (Part 16) to Front & Rear Legs

3

STEP 3A: Attach Left Side Upper Stabilizing Bar (Part F) to Right Side Upper Stabilizing Bar (Part G) using (1) M6x30mm Bolt/Nut/Cap Set (Part 9)

STEP 3B: Attach Upper Stabilizing Bar to Rear Legs using (4) M6x55mm Bolt/Nut/Cap Sets (Part 6)

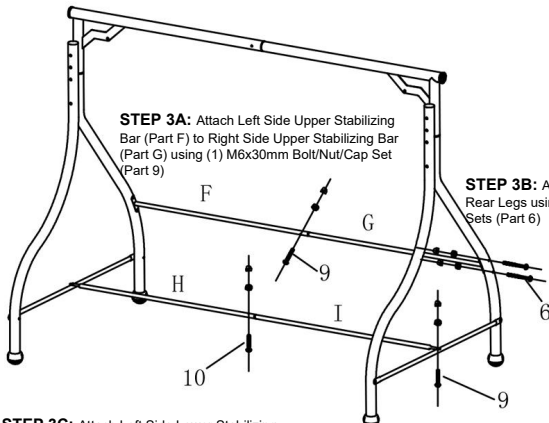

STEP 3C: Attach Left Side Lower Stabilizing Bar (Part H) to Right Side Lower Stabilizing Bar (Part I) using (1) M6x25mm Bolt/Nut/Cap Set (Part 10)

STEP 3D: Attach Lower Stabilizing Bar to Left & Right Side Braces using (2) M6x30mm Bolt/Nut/Cap Sets (Part 9)

4

STEP 4A: Add (8) Swing Attachment Bar Sleeves (Part 17) to both ends of the Swing Attachment Bars (Part J)

STEP 4D: Attach Rear Seat Bracket (Part Q) to Upper Seat Back using (1) M6x45mm Bolt/Nut/Cap Set (Part 7) **Note: Attach Facing Outward**

STEP 4E: Rest Swing Seat (Part M) on Front Seat Attachment Bar (Part L)

STEP 4B: Attach Swing Attachment Bars to Left & Right Swing Arms using (4) M6x40mm Bolt/Nut/Cap Sets (Part 8)

STEP 4C: Attach Front Seat Attachment Bar (Part L) to Left & Right Arms using (2) M8x40mm Front Bar Attachment Bolts (Part 3)

STEP 4F: Attach Upper Seat Frame to Left & Right Upper Arms using (2) M6x75mm Bolts (Part 5) and (2) Wing Nuts (Part 11). Attach Lower Seat Frame to Lower Arms using (2) Bolt/Nut/Cap Sets (Part 4) and (2) Spacers (Part 14)

6

STEP 6: Attach Left & Right Canopy Frames (Part O) using (2) Canopy Tilt Tension Knobs (Part 13)

5

STEP 5: Attach Swing Attachment Springs (Part 1) to Left and Right Swing Attachment Bars then hang on Left & Right Top Frame Posts

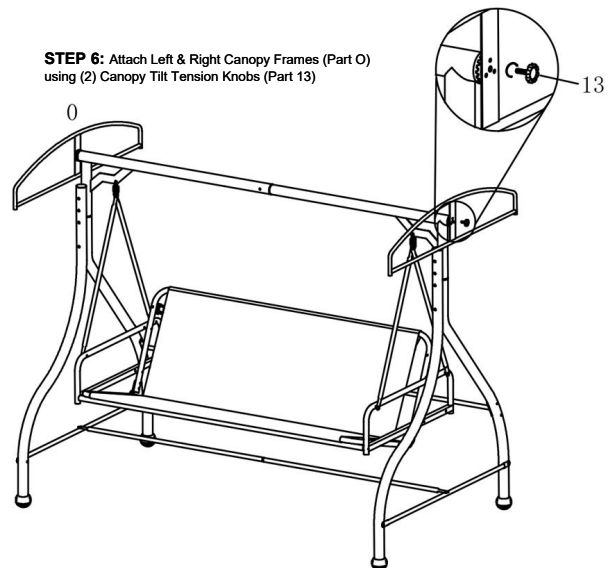
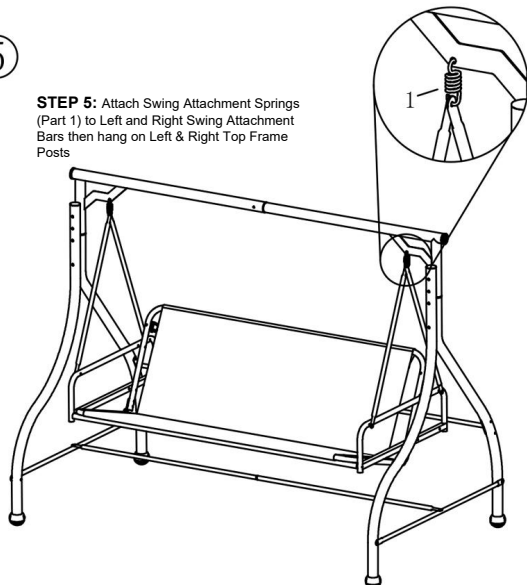

Thank you for your purchase!

STEP 2

7

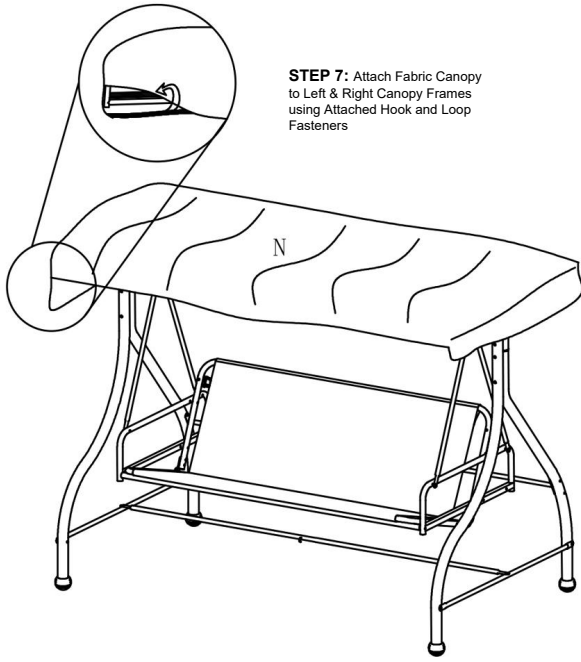

STEP 7: Attach Fabric Canopy to Left & Right Canopy Frames using Attached Hook and Loop Fasteners

8

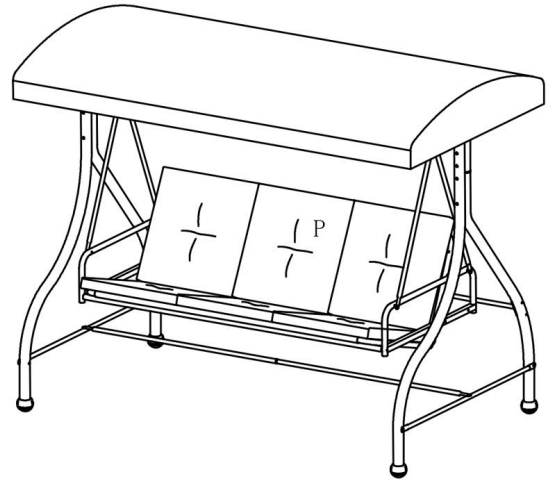

STEP 8: Position Seat and Back Cushions (Part P)

9

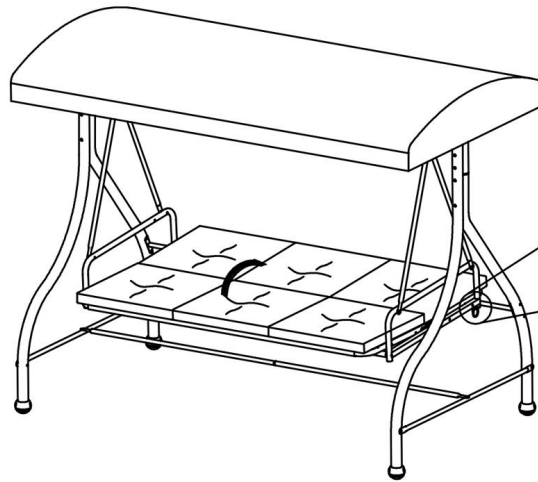

STEP 9 (When Reclined): Insert Locking Pin (Part Q) through Rear Seat Bracket Holes and Fasten Closed. Remove to return seat back to the upright position

12

LOOSEN CANOPY TENSION KNOBS TO ADJUST THE AMOUNT OF TILT. TIGHTEN WHEN PREFERRED ANGLE IS ACHIEVED

10

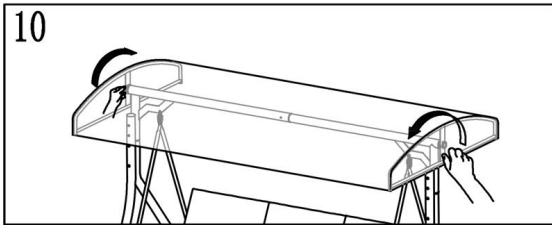

11

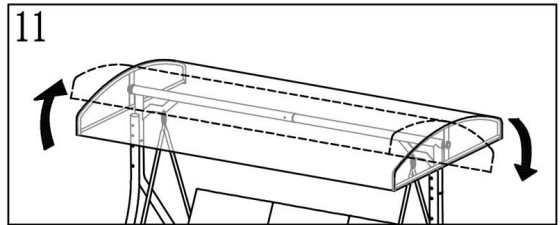

12

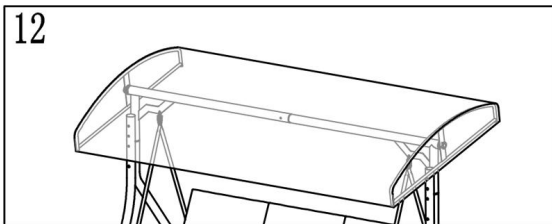

13

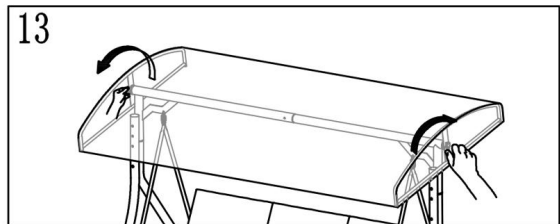

Thank you for your purchase!