

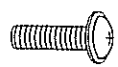





Model WL-A224V-GG/WL-A224V-LEA-GG Assembly Instructions

Parts Listing

- | | |
|---|--|
| A | B |
|  |  |
| 2PCS | 4PCS |
| C | D |
|  |  |
| 4PCS | 1PC |
| E | F |
|  |  |
| 1PC | 1PC |
| G | H |
|  |  |
| 1PC | 1PC |
-
- OPTIONAL
- | | |
|--|---|
| I | J |
|  |  |
| 6PCS | 2PCS |

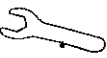
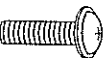
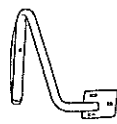
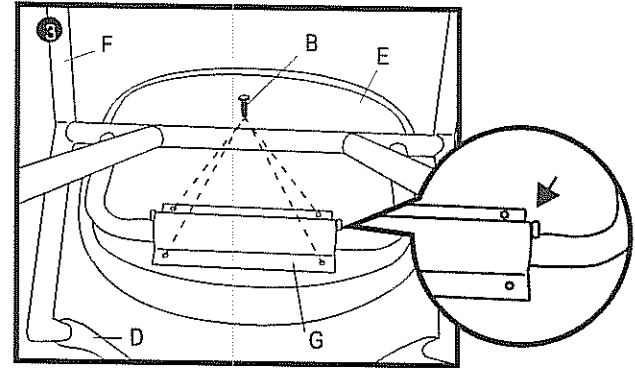
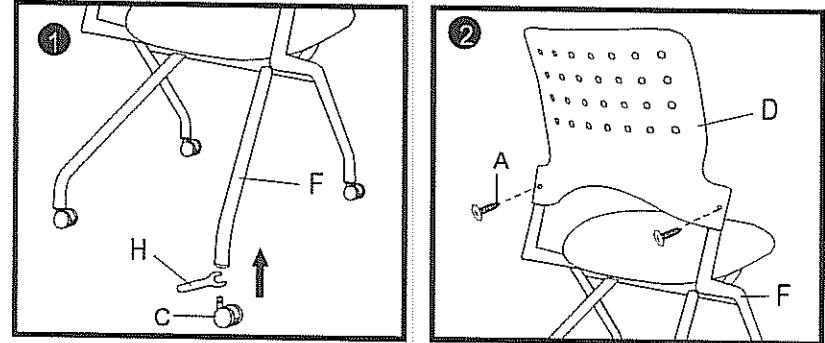
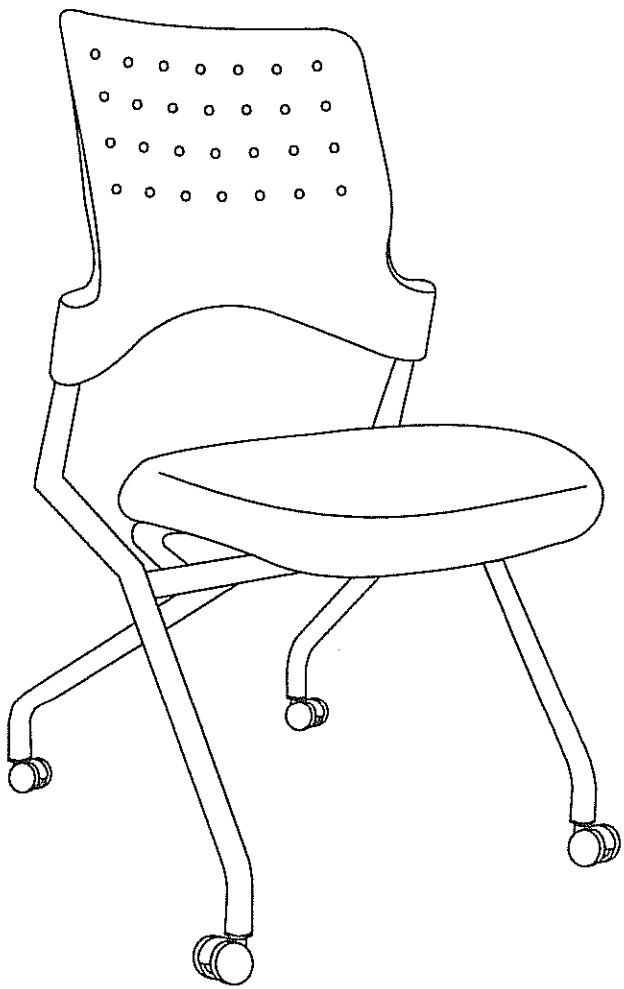

STEP3:

- Put flip-on mechanism(G) in the space between two small columns.
- Tighten the screws(B) evenly then completely.

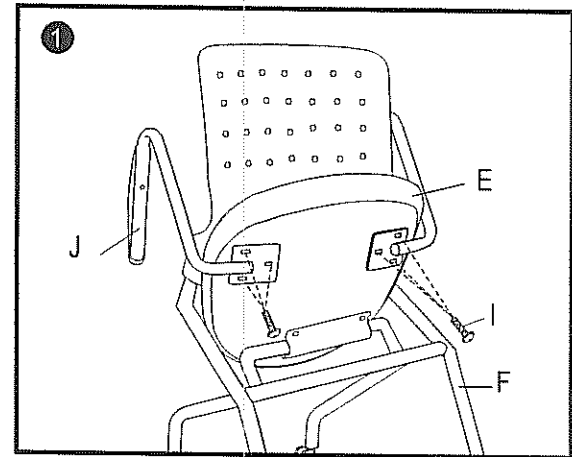

ASSEMBLY NOTES:
 During assembly, hand tighten screws only. When all screws are in place, you may then tighten all screws completely.
CAUTION: 1. Do not use this chair as a step ladder.
 2. Check for loose screws and tighten them anytime.